

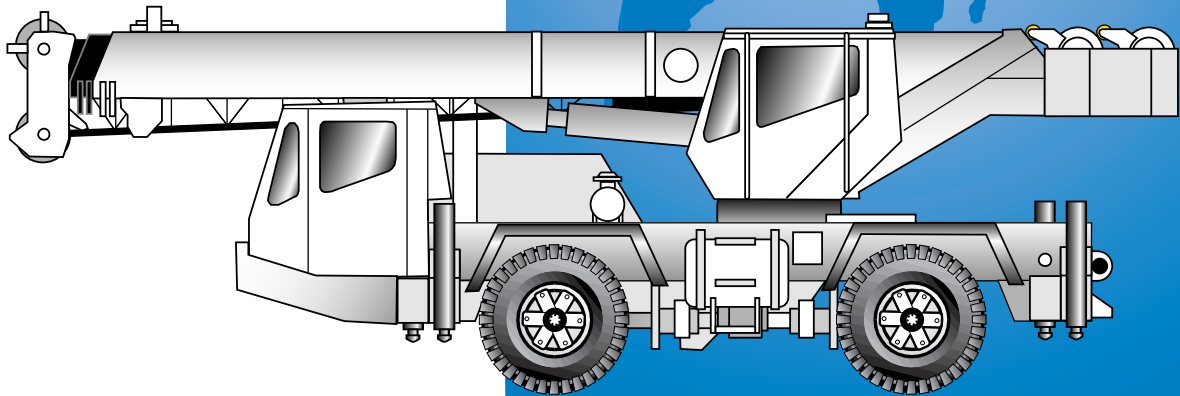

GROVE[®]
CRANE

A GROVE WORLDWIDE COMPANY

AT400 Series



All Terrain Hydraulic Crane

Dimensions

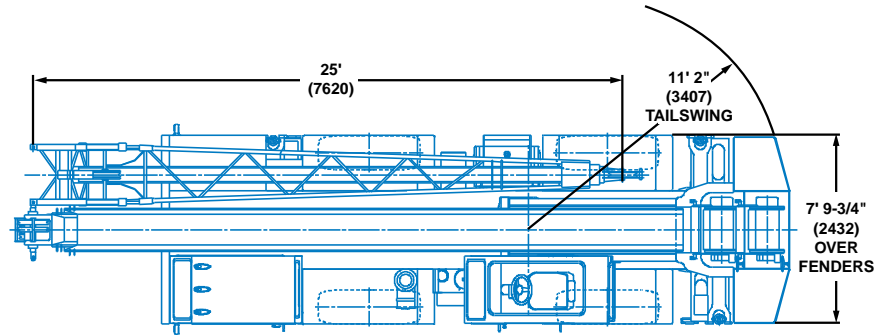

TURNING RADIUS - (2 Wheel Steer) 29' 6" (9029)
 (4 Wheel Steer) 20' 3" (6166)

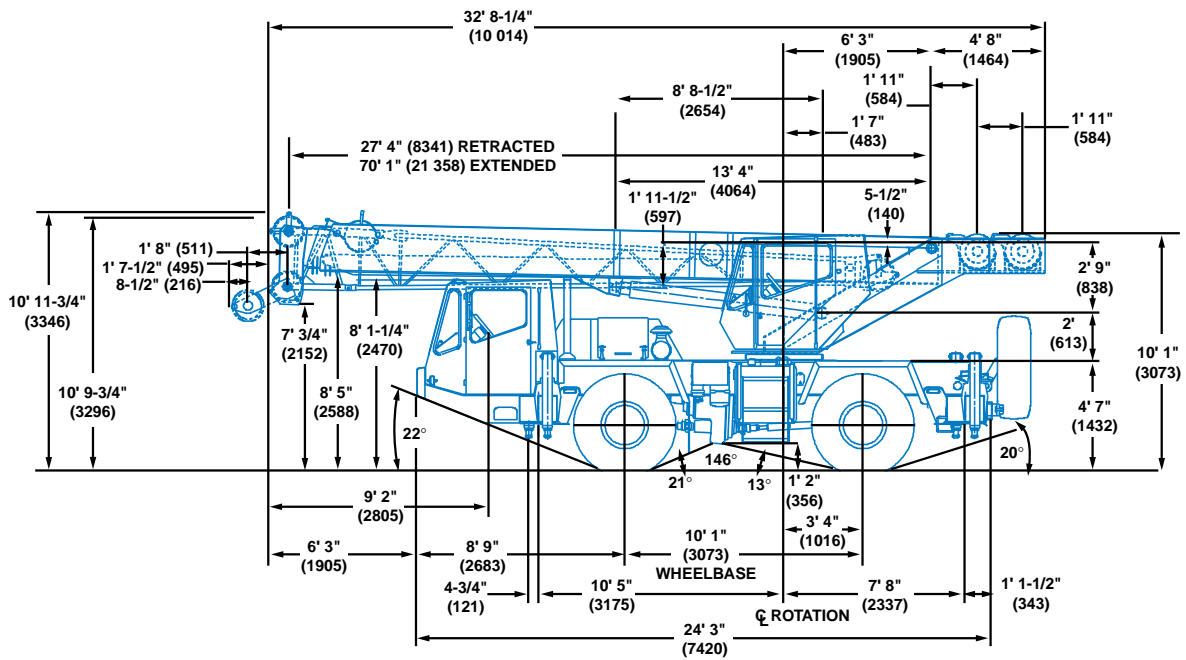

Working Range

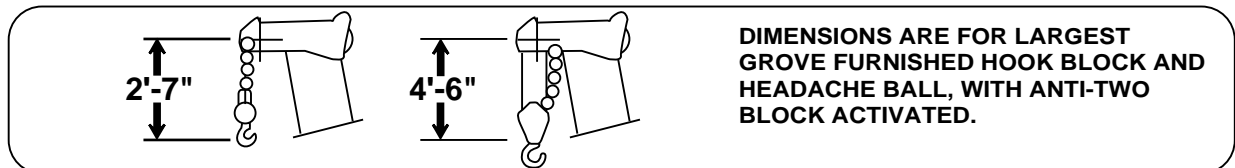
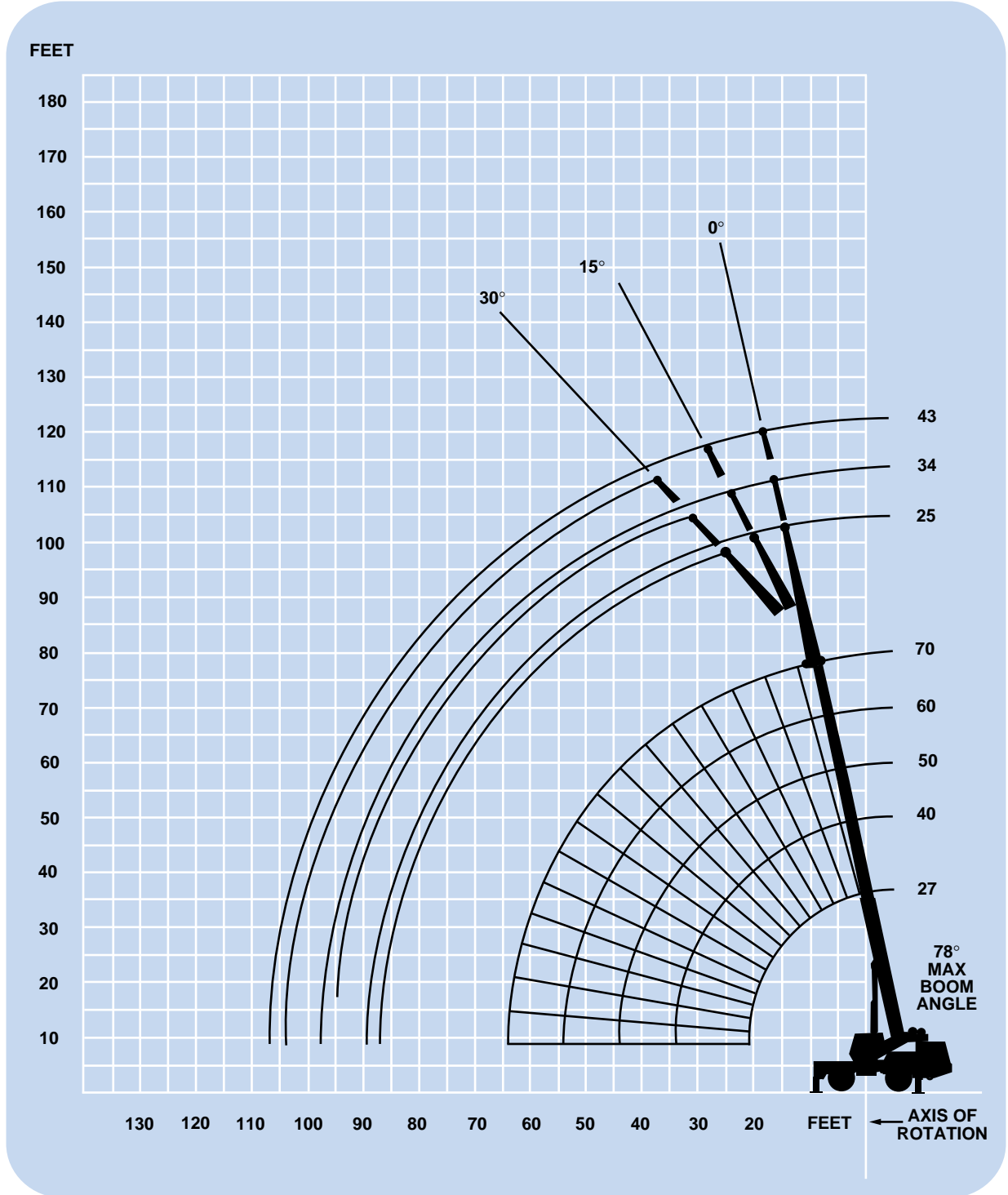

Superstructure specifications

Boom

27 ft. - 70 ft. (8.3 m - 21.4 m) three-section full power boom.
Maximum tip height: 78 ft. (23.8 m)

*Optional Swingaway Extension

25 ft. (7.6 m) lattice swingaway extension stows alongside base boom section.
Maximum tip height: 103 ft. (31.4 m)

*Optional Telescopic Swingaway Extension

25 ft. to 34 ft. or 43 ft. (7.6 m to 10.3 m or 13.1 m) telescopic lattice swingaway extension offsettable at 0°, 15° or 30°. Stows alongside base boom section.
Maximum tip height: 121 ft. (36.9 m)

Boom Nose

Three sheaves mounted on heavy duty tapered roller bearings with removable pin-type rope guards.
*Optional removable auxiliary boom nose with removable pin type rope guard.

Boom Elevation

One double acting hydraulic cylinder with integral holding valve provides elevation from -3° to 78°.

Load Moment & Anti-Two Block System

Standard load moment and anti-two block system with audio-visual warning and control lever lock-out. These systems provide electronic display of boom length, boom angle, radius, tip height, relative load moment, maximum permissible load, actual load and warning of impending two-block conditions.

Cab

Full vision, all steel fabricated with acoustical lining and tinted safety glass throughout. Deluxe seat incorporates armrest mounted hydraulic joystick controls. Dash panel incorporates gauges for all engine functions. Complete driving controls. Other standard features include: sliding side and rear windows, electric windshield wash-wipe, circulating air fan, skylight wiper, swing horn, fire extinguisher and seat belt.

Swing

Planetary swing with foot applied multi-disc wet brake. Spring applied, hydraulically released parking brake and plunger type, 2 position, mechanical 360° house lock, operated from cab.
Maximum speed: 2.0 RPM.

Counterweight

Integral with superstructure. Extra counterweight package available.

Hydraulic System

3 main gear pumps, combined capacity 90 G.P.M. (340 LPM) driven by carrier engine through P.T.O. Pump disconnect for travel.

Three individual valve banks.

Return line type filter with full flow by-pass protection and service indicator. Replaceable cartridge with micron filtration rating of 5/12/16.

66 gallon (250 L) reservoir.

Remote-mounted oil cooler with thermostatically controlled electric motor driven fan.

System pressure test ports with quick release type fittings for each circuit.

HOIST SPECIFICATIONS Main and Auxiliary Hoist

Planetary reduction with automatic spring applied multi-disc brake. Power up and down equal speed. Grooved drum. Electronic hoist drum rotation indicator.

Grove HO15C-16

Maximum Single Line Speed:	Bottom Layer	210 FPM (65 m/min)
	Intermediate Layer	245 FPM (75 m/min)
	Top Layer	265 FPM (81 m/min)
Maximum Single Line Pull:	Bottom Layer	8,100 lbs. (3675 kg)
	Intermediate Layer	7,400 lbs. (3355 kg)
	Top Layer	6,350 lbs. (2880 kg)

Maximum Permissible Line Pull w/5:1 Strength Factor: 8,100 lbs. (3675 kg)

Maximum Rope Stowage: 360 ft. (110 m) of 5/8" (16 mm)
Note: 360 ft. (110 m) length wire rope supplied with basic standard unit.

**Denotes optional equipment*

Carrier specifications

Chassis

Box section frame fabricated from high strength alloy steel. Integral outrigger housings and front/rear lifting, towing and tie down lugs.

Outrigger System

Hydraulic telescoping single stage, double box beam outriggers with inverted jack and integral holding valves. Three position setting, all steel fabricated, quick release type outrigger floats, 16.5 in. (429 mm) in diameter.

Outrigger Controls

Controls and crane level indicator located in cab.

Engine

Cummins 6BTA 5.9 six cylinders, turbocharged and after cooled, 359 cu. in. (5.9 L), 190 hp (141 kW) (gross) @ 2,500 RPM.

Maximum torque: 435 ft. lbs. (590 N.m) @ 1,700 RPM.

Fuel Tank Capacity

40 gallons (151 L).

Electrical System

Two 12 V - maintenance free batteries.

Drive

4 x 4

Steering

Full independent power steering:

Front: Mechanical with hydraulic power assist controlled by steering wheel.

Rear: Full hydraulic hand lever controlled. Provides infinite variations of 4 main steering modes: front only, rear only, crab and coordinated. Mechanically locked for highway travel.

Transmission

6 speeds forward and 3 reverse. Fully automatic APC 100 with engine mounted torque converter.

Axles

Front: Drive-steer with differential and planetary reduction hubs and differential locks.

Rear: Drive-steer with differential and planetary reduction hubs and differential locks.

Brakes

Dual line air system operating on all wheels. Spring-applied, air released. Parking brake acting on rear axles. Air dryer, Jacobs engine brake.

Tires

16.00R20 - 22PR on/off highway radials front and rear.

*Optional Tires

17.5R25 on/off highway radials front and rear.

Suspension

Leaf springs with shock absorbers all round, hydraulic lockout and automatic leveling system operated from cab.

Lights

Full lighting package including turn indicators, head and tail lights, brake and hazard warning lights.

Cab

One man design, all steel fabricated with acoustical lining and tinted safety glass throughout. Deluxe fabric covered, fully adjustable seat. Complete driving controls and engine instrumentation, including tilt telescope steering wheel, tachometer, speedometer, voltmeter, water temp., oil pressure, transmission temp., fuel level, dual air pressure gauges with A/V warning, and engine high temp./low oil pressure A/V warning. Other standard items include hot water heater/defroster, electric windshield wash/wipe, fire extinguisher, seat belt, door and window locks.

Maximum Speed

55 mph (90 kph)

Gradeability (Theoretical)

69.1% (Based on 40,000 lbs. [18 145 kg] GVW)

Gross Vehicle Weight

Basic unit 37,780 lbs. (17 135 kg).

Miscellaneous Standard Equipment

Full width fenders, dual rear view mirrors, electronic back-up alarm, light package, pump disconnect, engine distress A/V warning, tire inflation kit, worklights, air cleaner restriction indicator.

*Optional Equipment

- * Auxiliary hoist
- * 360° rotating beacon
- * Cab spotlight
- * Engine block heater
- * Electric skylight wiper
- * Diesel or hydraulic heater/defroster
- * Hookblocks
- * Spare wheel assembly and stowage rack
- * Tool kit
- * Pintle hook - rear

**Denotes optional equipment*

Weight Reductions for Load Handling Devices

25 ft. (7.6 m) Fixed Extension

*25 ft. (7.6 m) extension (stowed)	293 lbs.	(133 kg)
*25 ft. (7.6 m) extension (erected)	1,563 lbs.	(709 kg)

25 ft. - 43 ft. (7.6 m - 13.1 m) Tele. Boom Extension

*25 ft. - 43 ft. (7.6 m - 13.1 m) extension (stowed)	535 lbs.	(243 kg)
*25 ft. - 43 ft. (7.6 m - 13.1 m) extension (erected [ret.])	3,906 lbs.	(1772 kg)
*25 ft. - 43 ft. (7.6 m - 13.1 m) extension (erected [ext.])	4,995 lbs.	(2266 kg)

*Reduction of main boom capacities:

When lifting over swingaway and/or jib combinations, deduct total weight of all load handling devices reeved over main boom nose directly from swingaway or jib capacity.

NOTE: All load handling devices and boom attachments are considered part of the load and suitable allowances **MUST BE MADE** for their combined weights. Weights are for Grove furnished equipment.

HOOKBLOCKS:

+ 22 ton, 3 sheave	499 lbs.	(226 kg)
+ 15 ton, 2 sheave	462 lbs.	(210 kg)
+ 12 ton, 1 sheave	360 lbs.	(163 kg)
+ 5 ton headache ball	172 lbs.	(78 kg)
+ Auxiliary boom head	145 lbs.	(66 kg)

+ Refer to rating plate for actual weight.



27-70 ft.
(8.3-21.4 m)



3,685 lbs.
(1670 kg)



100%



360°



85% Domestic (Pounds)

25 ft. Ext.
& 70 ft.

(Feet)	27	40	50	60	70	95
8	44,000 (64)	43,650 (73)	42,450 (76.5)			
9	41,000 (61.5)	41,000 (71.5)	39,850 (75.5)			
10	40,000 (59)	38,000 (70)	37,550 (74)			
12	31,450 (54)	31,450 (66.5)	31,450 (71.5)	31,450 (75.5)		
15	24,300 (45)	24,300 (61.5)	24,300 (68)	24,300 (72)	22,000 (76.5)	
20	18,000 (23)	17,650 (52.5)	17,650 (61.5)	17,650 (67)	17,650 (72)	12,500 (78)
25		13,300 (42)	13,300 (54.5)	13,300 (61.5)	13,300 (67)	10,750 (74.5)
30		10,400 (28.5)	10,400 (46.5)	10,400 (55.5)	10,400 (62.5)	9,810 (71)
35			8,580 (37.5)	8,580 (49.5)	8,580 (57.5)	8,930 (67.5)
40			7,000 (25)	7,000 (42.5)	7,000 (52)	8,090 (64)
45				5,840 (34)	5,840 (46)	6,720 (60.5)
50				4,800 (23.5)	4,800 (39.5)	5,490 (57)
55					3,900 (31.5)	4,520 (52.5)
60					3,200 (21.5)	3,740 (48.5)
65						3,100 (44)
70						2,560 (39)
75						2,090 (33.5)
80						1,700 (27)
85						1,350 (18.5)
Minimum boom angle (deg.) for indicated length (no load)					0	0
Maximum boom length (ft.) at 0 deg. boom angle (no load)					70	95

NOTE: () Boom angles are in degrees.

Boom Angle	27	40	50	60	70
0°	13,050 (21.1)	7,920 (33.7)	5,700 (43.7)	4,190 (53.7)	2,930 (63.8)

NOTE: () Boom angles are in degrees.

A6-829-008801



27-70 ft.
(8.3-21.4 m)



3,685 lbs.
(1670 kg)



50%



360°



85% Domestic (Pounds)

25 ft. Ext.
& 70 ft.

(Feet)	27	40	50	60	70	95
8	39,700 (64)	39,700 (73)	39,700 (76.5)			
9	36,800 (61.5)	36,800 (71.5)	36,800 (75.5)			
10	34,200 (59)	34,200 (70)	34,200 (74)			
12	29,900 (54)	29,900 (66.5)	29,900 (71.5)	29,000 (75.5)		
15	24,300 (45)	24,300 (61.5)	24,300 (68)	23,200 (72)	22,000 (76.5)	
20	14,700 (23)	14,700 (52.5)	14,700 (61.5)	14,700 (67)	14,700 (72)	12,500 (78)
25		9,970 (42)	9,970 (54.5)	9,970 (61.5)	9,970 (67)	10,600 (74.5)
30		7,250 (28.5)	7,250 (46.5)	7,250 (55.5)	7,250 (62.5)	8,230 (71)
35			5,490 (37.5)	5,490 (49.5)	5,490 (57.5)	6,440 (67.5)
40			4,250 (25)	4,250 (42.5)	4,250 (52)	5,020 (64)
45				3,340 (34)	3,340 (46)	3,970 (60.5)
50				2,630 (23.5)	2,630 (39.5)	3,160 (57)
55					2,070 (31.5)	2,510 (52.5)
60					1,620 (21.5)	1,990 (48.5)
65						1,560 (44)
70						1,190 (39)
Minimum boom angle (deg.) for indicated length (no load)					0	33.5
Maximum boom length (ft.) at 0 deg. boom angle (no load)					70	50
NOTE: () Boom angles are in degrees.						

Boom Angle	27	40	50	60	70
0°	13,050 (21.1)	5,890 (33.7)	3,550 (43.7)	2,210 (53.7)	1,330 (63.8)

NOTE: () Reference radii in feet.

A6-829-012447



27-70 ft.
(8.3-21.4 m)



3,685 lbs.
(1670 kg)



0%



360°



(Feet)



75% Domestic (Pounds)

(Feet)	27	40	50	60	70
8	28,700 (64)	28,700 (73)	27,100 (76.5)		
9	22,700 (61.5)	22,700 (71.5)	21,950 (75.5)		
10	18,650 (59)	18,650 (70)	18,650 (74)		
12	13,500 (54)	13,500 (66.5)	13,500 (71.5)	13,500 (75.5)	
15	9,250 (45)	9,250 (61.5)	9,250 (68)	9,250 (72)	9,250 (76.5)
20	5,640 (23)	5,640 (52.5)	5,640 (61.5)	5,640 (67)	5,640 (72)
25		3,730 (42)	3,730 (54.5)	3,730 (61.5)	3,730 (67)
30		2,550 (28.5)	2,550 (46.5)	2,550 (55.5)	2,550 (62.5)
35			1,740 (37.5)	1,740 (49.5)	1,740 (57.5)
40			1,160 (25)	1,160 (42.5)	1,160 (52)
Minimum boom angle (deg.) for indicated length (no load)					46.5
Maximum boom length (ft.) at 0 deg. boom angle (no load)					50
NOTE: () Boom angles are in degrees.					

Boom Angle	27	40
0°	5,120 (21.1)	1,930 (33.7)

NOTE: () Reference radii in feet.

A6-829-012448



27-70 ft.
(8.3-21.4 m)

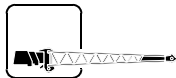

25 ft.
(7.6 m)



3,685 lbs.
(1670 kg)



100%



360°



(Feet)



85% Domestic (Pounds)

	0° OFFSET	15° OFFSET	30° OFFSET
20	*12,500 (78)		
25	10,750 (75)	7,500 (78)	
30	9,810 (71.5)	6,870 (74.5)	*5,500 (78)
35	8,930 (68)	6,330 (71)	5,110 (74.5)
40	7,860 (64.5)	5,860 (67.5)	4,770 (71)
45	6,220 (61)	5,450 (64)	4,490 (67.5)
50	4,960 (57)	4,960 (60)	4,260 (63.5)
55	3,970 (53)	3,970 (56)	3,970 (59.5)
60	3,170 (49)	3,170 (52)	3,170 (55.5)
65	2,510 (44)	2,510 (47)	2,510 (50.5)
70	1,960 (39.5)	1,960 (42.5)	1,960 (45.5)
75	1,480 (33.5)	1,480 (36.5)	1,480 (40)
80	1,080 (27)	1,080 (30)	1,080 (32.5)

NOTE: () Boom angles are in degrees.

*This capacity is based upon the maximum boom angle.

A6-829-008847



27-70 ft.
(8.3-21.4 m)

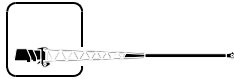

25-43 ft.
(7.6-13.1 m)



3,685 lbs.
(1670 kg)



100%



360°



(Feet)



85% Domestic (Pounds)

(Feet)	25' LENGTH			34' LENGTH			43' LENGTH		
	0°	15°	30°	0°	15°	30°	0°	15°	30°
20	*12,500 (78.0)			*8,500 (78.0)			*5,000 (78.0)		
25	10,750 (75.0)	7,500 (78.0)		8,030 (77.0)			4,750 (77.5)		
30	9,810 (71.5)	6,870 (74.5)	*5,500 (78.0)	7,170 (74.0)	*5,500 (78.0)		4,360 (75.0)		
35	8,930 (68.0)	6,330 (71.0)	5,110 (74.5)	6,390 (71.0)	4,910 (75.5)	*3,600 (78.0)	4,020 (72.0)	3,000 (78.0)	
40	7,860 (64.5)	5,860 (67.5)	4,770 (71.0)	5,680 (68.0)	4,540 (72.5)	3,290 (76.0)	3,710 (69.5)	2,800 (75.5)	*2,300 (78.0)
45	6,220 (61.0)	5,450 (64.0)	4,490 (67.5)	5,040 (65.0)	4,180 (69.0)	2,930 (72.5)	3,420 (66.5)	2,650 (72.5)	2,210 (76.5)
50	4,960 (57.0)	4,960 (60.0)	4,260 (63.5)	4,590 (61.5)	3,840 (66.0)	2,650 (69.5)	3,170 (64.0)	2,510 (70)	2,160 (73.5)
55	3,970 (53.0)	3,970 (56.0)	3,970 (59.5)	4,200 (58.5)	3,510 (62.5)	2,430 (66.0)	2,940 (61.0)	2,400 (67.0)	2,100 (70.5)
60	3,170 (49.0)	3,170 (52.0)	3,170 (55.5)	3,520 (55.0)	3,200 (59.0)	2,250 (62.0)	2,730 (58.0)	2,300 (64.0)	2,030 (67.0)
65	2,510 (44.0)	2,510 (47.0)	2,510 (50.5)	2,910 (51.0)	2,900 (55.5)	2,100 (58.5)	2,540 (54.5)	2,210 (60.5)	1,970 (63.5)
70	1,960 (39.5)	1,960 (42.5)	1,960 (45.5)	2,390 (47.5)	2,390 (51.5)	1,970 (54.0)	2,360 (51.5)	2,130 (57.5)	1,890 (60.0)
75	1,480 (33.5)	1,480 (36.5)	1,480 (40)	1,960 (43)	1,960 (47)	1,850 (49.5)	2,140 (48.0)	2,060 (54.0)	1,820 (56.5)
80	1,080 (27)	1,080 (30)	1,080 (32.5)	1,580 (38.5)	1,580 (42.5)	1,580 (44.5)	2,010 (44.0)	2,000 (50.0)	1,730 (52.0)
85				1,250 (33)	1,250 (37)	1,250 (39)	1,670 (40)	1,670 (46)	1,640 (48)
90							1,370 (35.5)	1,370 (41.5)	1,370 (42.5)
95							1,100 (30.5)	1,100 (36.5)	

NOTE: () Boom angles are in degrees.

*This capacity is based upon maximum boom angle.

A6-829-008810



27-70 ft.
(8.3-21.4 m)

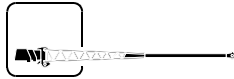

25-43 ft.
(7.6-13.1 m)



3,685 lbs.
(1670 kg)



50%



360°



(Feet)



85% Domestic (Pounds)

(Feet)	25' LENGTH			34' LENGTH			43' LENGTH		
	0°	15°	30°	0°	15°	30°	0°	15°	30°
20	<u>*12,500</u> (78.0)			<u>*8,500</u> (78.0)			<u>*5,000</u> (78.0)		
25	<u>9,930</u> (75.0)	<u>7,500</u> (78.0)		<u>8,030</u> (77.0)			<u>4,750</u> (77.5)		
30	<u>7,520</u> (71.5)	<u>6,870</u> (74.5)	<u>*5,500</u> (78.0)	<u>7,170</u> (74.0)	<u>*5,500</u> (78.0)		<u>4,360</u> (75.0)		
35	<u>5,680</u> (68.0)	<u>5,680</u> (71.0)	<u>5,110</u> (74.5)	<u>5,500</u> (71.0)	<u>4,910</u> (75.5)	<u>*3,600</u> (78.0)	<u>4,020</u> (72.0)	<u>3,000</u> (78.0)	
40	<u>4,280</u> (64.5)	<u>4,280</u> (67.5)	<u>4,280</u> (71.0)	<u>4,260</u> (68.0)	<u>4,260</u> (72.5)	<u>3,290</u> (76.0)	<u>3,710</u> (69.5)	<u>2,800</u> (75.5)	<u>*2,300</u> (78.0)
45	<u>3,220</u> (61.0)	<u>3,220</u> (64.0)	<u>3,220</u> (67.5)	<u>3,320</u> (65.0)	<u>3,320</u> (69.0)	<u>2,930</u> (72.5)	<u>3,420</u> (66.5)	<u>2,650</u> (72.5)	<u>2,210</u> (76.5)
50	<u>2,390</u> (57.0)	<u>2,390</u> (60.0)	<u>2,390</u> (63.5)	<u>2,580</u> (61.5)	<u>2,580</u> (66.0)	<u>2,580</u> (69.5)	<u>3,150</u> (64.0)	<u>2,510</u> (70)	<u>2,160</u> (73.5)
55	<u>1,720</u> (53.0)	<u>1,720</u> (56.0)	<u>1,720</u> (59.5)	<u>1,980</u> (58.5)	<u>1,980</u> (62.5)	<u>1,980</u> (66.0)	<u>2,510</u> (61.0)	<u>2,400</u> (67.0)	<u>2,100</u> (70.5)
60	<u>1,170</u> (49.0)	<u>1,170</u> (52.0)	<u>1,170</u> (55.5)	<u>1,500</u> (55.0)	<u>1,500</u> (59.0)	<u>1,500</u> (62.0)	<u>1,990</u> (58.0)	<u>1,990</u> (64.0)	<u>1,990</u> (67.0)
65				<u>1,090</u> (51.0)	<u>1,090</u> (55.5)	<u>1,090</u> (58.5)	<u>1,560</u> (54.5)	<u>1,560</u> (60.5)	<u>1,560</u> (63.5)
70							<u>1,190</u> (51.5)	<u>1,190</u> (57.5)	<u>1,190</u> (60.0)

NOTE: () Boom angles are in degrees.

*This capacity is based upon maximum boom angle.

A6-829-013943



27-70 ft.
(8.3-21.4 m)



3,685 lbs.
(1670 kg)



16.00R20/21 Tires
Stationary



Defined Arc
Over Rear



(Feet)



75% Domestic (Pounds)

(Feet)	27	40	50	60	70
8	27,500 (64)	24,100 (73)			
9	24,400 (61.5)	21,300 (71.5)	19,400 (75.5)		
10	22,100 (59)	19,000 (70)	17,450 (74)		
12	18,800 (54)	15,500 (66.5)	14,400 (71.5)	13,400 (75.5)	
15	12,850 (45)	11,850 (61.5)	11,150 (68)	10,500 (72)	9,920 (76.5)
20	7,680 (23)	7,680 (52.5)	7,680 (61.5)	7,410 (67)	7,060 (72)
25		5,230 (42)	5,230 (54.5)	5,230 (61.5)	5,200 (67)
30		3,780 (28.5)	3,780 (46.5)	3,780 (55.5)	3,780 (62.5)
35			2,790 (37.5)	2,790 (49.5)	2,790 (57.5)
40			2,070 (25)	2,070 (42.5)	2,070 (52)
45				1,520 (34)	1,520 (46)
50				1,090 (23.5)	1,090 (39.5)

NOTE: () Boom angles are in degrees.

Boom Angle	27	40	50	60
0°	6,920 (21.1)	3,010 (33.7)	1,650 (43.7)	820 (53.7)

NOTE: () Boom angles are in degrees.

A6-829-008923



27-70 ft.
(8.3-21.4 m)



3,685 lbs.
(1670 kg)



16.00R20/21 Tires
Stationary



360°



(Feet)



75% Domestic (Pounds)

(Feet)	27	40	50	60	70
8	22,550 (64)	22,550 (73)			
9	19,500 (61.5)	19,500 (71.5)	18,000 (75.5)		
10	17,100 (59)	17,100 (70)	16,300 (74)		
12	13,400 (54)	13,400 (66.5)	13,400 (71.5)	12,550 (75.5)	
15	8,930 (45)	8,930 (61.5)	8,930 (68)	8,930 (72)	7,620 (76.5)
20	5,030 (23)	5,030 (52.5)	5,030 (61.5)	5,030 (67)	5,030 (72)
25		3,230 (42)	3,230 (54.5)	3,230 (61.5)	3,230 (67)
30		2,180 (28.5)	2,180 (46.5)	2,180 (55.5)	2,180 (62.5)
35			1,460 (37.5)	1,460 (49.5)	1,460 (57.5)
40			940 (25)	940 (42.5)	940 (52)

NOTE: () Boom angles are in degrees.

Boom Angle	27	40	50
0°	4,460 (21.1)	1,620 (33.7)	630 (43.7)

NOTE: () Boom angles are in degrees.

A6-829-008924



27-70 ft.
(8.3-21.4 m)



3,685 lbs.
(1670 kg)



Pick & Carry
Up to 2.5 MPH
16.00R20/21 Tires



Boom Centered
Over Rear



(Feet)



75% Domestic (Pounds)

(Feet)	27	40	50	60	70
8	24,100 (64)	24,100 (73)			
9	22,200 (61.5)	22,200 (71.5)	21,800 (75.5)		
10	20,550 (59)	20,550 (70)	20,250 (74)		
12	17,700 (54)	17,700 (66.5)	17,700 (71.5)	12,550 (75.5)	
15	12,850 (45)	12,850 (61.5)	12,850 (68)	10,300 (72)	9,530 (76.5)
20	7,680 (23)	7,680 (52.5)	7,680 (61.5)	7,670 (67)	7,050 (72)
25		5,230 (42)	5,230 (54.5)	5,230 (61.5)	5,230 (67)
30		3,780 (28.5)	3,780 (46.5)	3,780 (55.5)	3,780 (62.5)
35			2,790 (37.5)	2,790 (49.5)	2,790 (57.5)
40			2,070 (25)	2,070 (42.5)	2,070 (52)
45				1,520 (34)	1,520 (46)
50				1,090 (23.5)	1,090 (39.5)

NOTE: () Boom angles are in degrees.

Boom Angle	27	40	50	60
0°	6,920 (21.1)	3,010 (33.7)	1,650 (43.7)	820 (53.7)

NOTE: () Boom angles are in degrees.

A6-829-008925

NOTES:

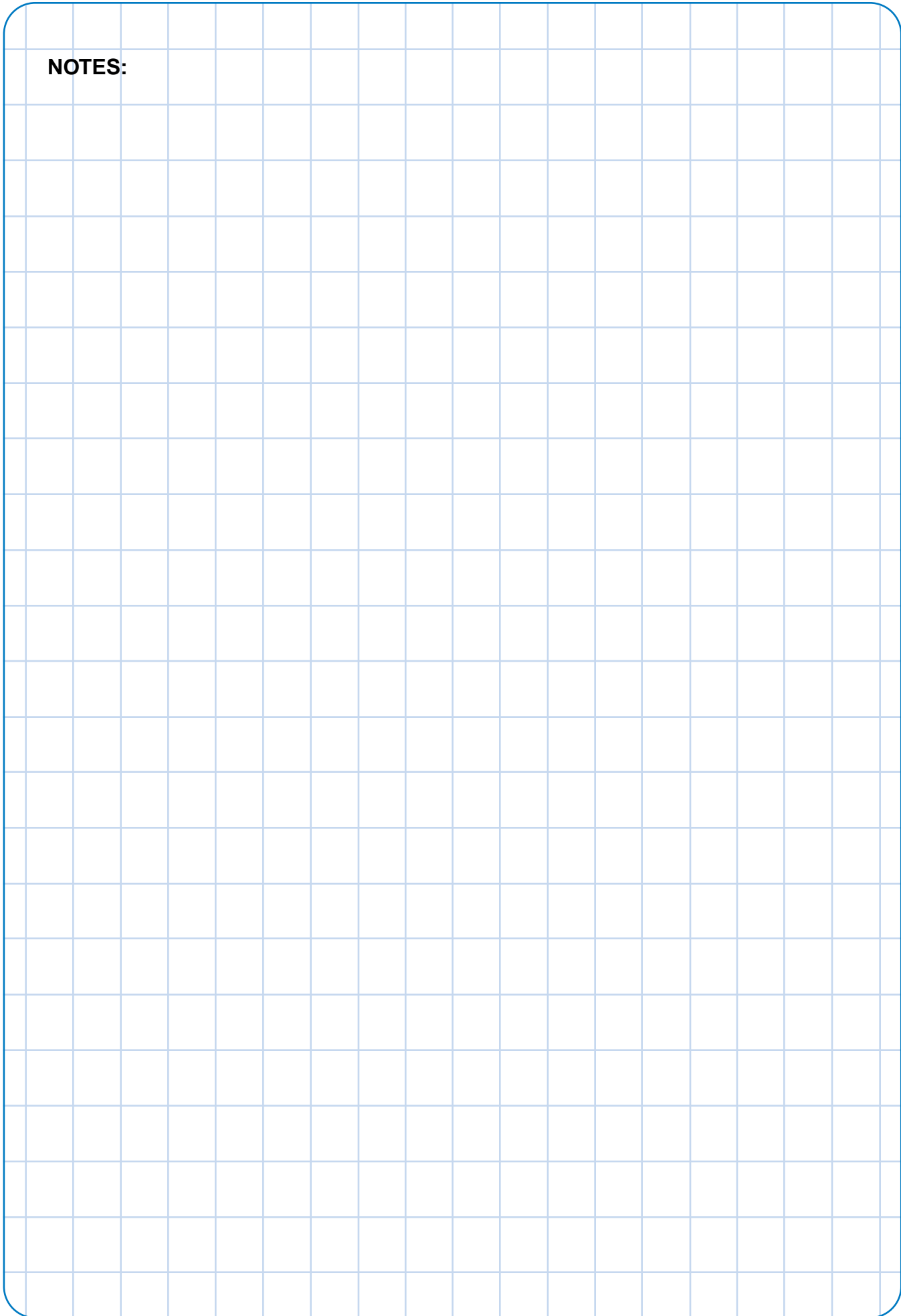

Rated Lifting Capacities

IMPORTANT NOTES:

WARNING: THIS CHART IS ONLY A GUIDE.

The notes below are for illustration only and should not be relied upon to operate the crane. The individual crane's load chart, operating instructions and other instruction plates must be read and understood prior to operating the crane.

1. All rated loads have been tested to and meet minimum requirements of SAEJ1063 NOV93 - Cantilevered Boom Crane Structures - Method of Test, perform to SAEJ765 OCT90 Crane Stability Test Code.

2. Capacities given do not include the weight of hook blocks, slings, auxiliary lifting equipment and load handling devices. Their weights MUST be added to the load to be lifted. When more than minimum required reeving is used, the additional rope weight shall be considered part of the load.





































3. Capacities appearing above the bold line are based on structural strength and tipping should not be relied upon as a capacity limitation.

4. All capacities are for crane on firm, level surface. It may be necessary to have structural supports under the outrigger floats to spread the load to a larger bearing surface.

5. When either boom length or radius or both are between values listed, the smallest load shown at either the next larger radius or boom length shall be used.

6. For outrigger operation, ALL outriggers shall be properly extended with tires raised free of ground before raising the boom or lifting loads.

Symbols Glossary

	Frame		Steering
	Outriggers		Transmission
	Outrigger Controls		Axles
	Engine		Brakes
	Fuel Tank Capacity		Tires
	Electrical System		Suspension
	Drive		360° Rotation
	Lights		Boom Elevation
	Cab		Swing
	Boom		Counterweight
	Fixed Swingaway		Oil
	Tele-Swingaway		Hydraulic System
	Jib		Hoist
	Boom Nose		Radius
	Boom Extension		Boom Length
	Speed		Hookblock
	Grade		Gear
	Lattice Extension		Luffing Jib

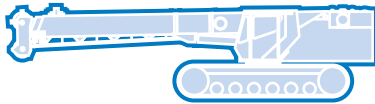
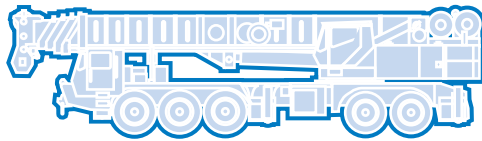
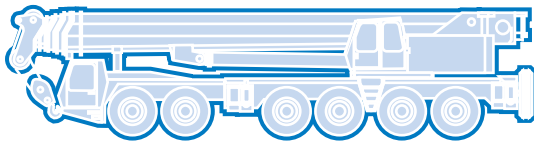
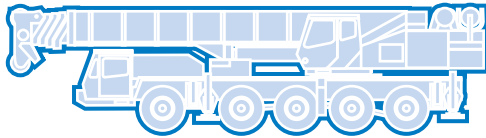
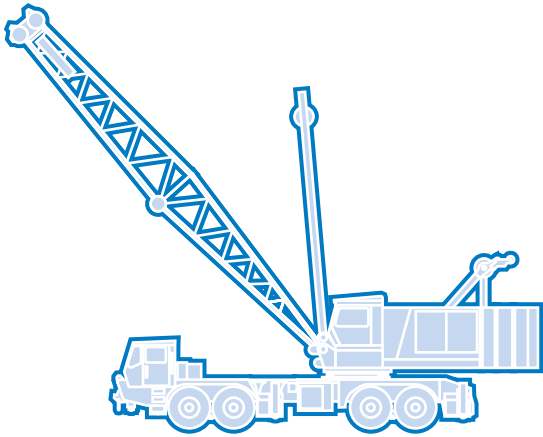

Grove Worldwide – World Headquarters

Grove North America
1565 Buchanan Trail East
P.O. Box 21
Shady Grove, Pennsylvania 17256, U.S.A.
Tel: [Int + 1] (717) 597-8121
Fax: [Int + 1] (717) 597-4062
Western Hemisphere, Asia/Pacific

Grove Europe Limited*

Sunderland SR4 6TT, England
Tel: [Int + 44] 191 565-6281
Fax: [Int + 44] 191 564-0442
Europe, Africa, Middle East

Grove Europe Limited*

P.O. Box No. 268
4A Kimber Road
Abingdon, Oxfordshire, OX141SG
Tel: [Int + 44] 1235 55-3184
Fax: [Int + 44] 1235 55-3218

**Deutsche Grove GmbH
Sales and Service**

Helmholtzstrasse 12, Postfach 5026
D-40750 Langenfeld, Germany
Tel: [Int + 49] (2173) 8909-0
Fax: [Int + 49] (2173) 8909-30

Wilhelmshaven Works

Industriegelände West, Postfach 1853
D-26358 Wilhelmshaven, Germany
Tel: [Int + 49] (4421) 294-0
Fax: [Int + 49] (4421) 294-301

Grove France S.A.

16, chaussée Jules-César, 95520 OSNY
B.P. 203, 95523 CERGY PONTOISE CEDEX
France
Tel: [Int + 33] (1) 30313150
Int: [Int + 33] (1) 30386085

*Grove Europe Limited, Registered in England,
Number 1845128, Registered office, Crown Works,
Pallion, Sunderland, Tyne & Wear, England SR4 6TT

Grove Asia/Pacific - Regional Office

171 Chin Swee Road
#06-01 San Centre
Singapore 0316
Tel: [Int + 65] 536-6112
Fax: [Int + 65] 536-6119
Asia/Pacific, Near East

Grove China - Representative Office

Beijing Hotel Room 6074
No. 33 East Chang An Avenue
Beijing, 100004, China
Tel: [Int + 86] (10) 513-7766
Fax: [Int + 86] (10) 513-7307

Grove Product Support

Western Hemisphere, Asia/Pacific
1086 Wayne Avenue
Chambersburg, Pennsylvania USA
Tel: [Int + 1] (717) 263-5100
Fax: [Int + 1] (717) 267-0404

Europe, Africa, Middle East
Sunderland SR4 6TT, England
Tel: [Int + 44] 191 565-6281
Parts Fax: [Int + 44] 191 510-9242
Service Fax: [Int + 44] 191 510-9560

Constant improvement and engineering progress make it necessary that we reserve the right to make specification, equipment, and price changes without notice. Illustrations shown may include optional equipment and accessories and may not include all standard equipment.

Distributed By: